

Decay of metastable topological defects

John Preskill

California Institute of Technology, Pasadena, California 91125

Alexander Vilenkin*

California Institute of Technology, Pasadena, California 91125

and Lyman Laboratory of Physics, Harvard University, Cambridge, Massachusetts 02138

(Received 9 September 1992)

We systematically analyze the decay of metastable topological defects that arise from the spontaneous breakdown of gauge or global symmetries. Quantum-mechanical tunneling rates are estimated for a variety of decay processes. The decay rate for a global string, vortex, domain wall, or kink is typically suppressed compared to the decay rate for its gauged counterpart. We also discuss the decay of global texture, and of semilocal and electroweak strings.

PACS number(s): 98.80.Cq, 11.15.Ex, 11.15.Kc, 11.17.+y

I. INTRODUCTION

Topological defects arise as stable solutions of classical field equations in a variety of models with spontaneously broken symmetries. The higher symmetry usually characterizes the high-temperature phase of the model, and the symmetry breaking corresponds to a phase transition. The type of defects formed at a phase transition depends on the topology of the vacuum manifold, $M = G/H$, where G and H are, respectively, the symmetry groups before and after the symmetry breaking [1-4].

Linear defects, or strings, are formed if the first homotopy group is nontrivial, $\pi_1(M) \neq I$; point defects, or monopoles, are formed if $\pi_2(M) \neq I$; and sheetlike defects, or domain walls, are formed if $\pi_0(M) \neq I$. These defects are stable in the sense that "unwinding" the topological knots associated with the defects would require going over an infinitely high potential barrier. The physical properties of defects crucially depend on whether the broken symmetry is gauge or global. For example, the mass of a global monopole and the mass per unit length of a global string are infrared divergent, while the corresponding quantities for gauge defects are finite.

The purpose of this paper is to give a systematic account of the decay of *metastable* defects in relativistic field theories. A metastable defect is a stable solution to the classical field equations, stable in the sense that small vibrations about the solution have nonnegative frequency squared. But a metastable defect can be unwound by going over a *finite* potential barrier; hence, it can decay quantum mechanically. In the limit of small \hbar , the decay rate approaches zero like $e^{-B/\hbar}$. We will describe how the "tunneling action" B can be calculated for various types of metastable defects.

One type of metastable defect can arise in models with a sequence of phase transitions:

$$G \rightarrow H_1 \rightarrow H_2 . \quad (1.1)$$

Defects will be formed if the manifolds $M_1 = G/H_1$ and $M_2 = H_1/H_2$ have nontrivial homotopy groups. However, these defects will not be topologically stable if $M = G/H_2$ has trivial topology. Consider, for example, the sequence

$$G \rightarrow Z_2 \rightarrow I , \quad (1.2)$$

with $\pi_0(G) = \pi_1(G) = I$. Since $\pi_1(G/Z_2) = Z_2$ and $\pi_0(Z_2) = Z_2$, the first phase transition gives rise to strings and the second to domain walls. However, it can be shown [5,6] that strings formed at the first phase transition become boundaries of the walls formed at the second phase transition. Closed and infinite walls without boundaries can also be formed, but they are not topologically stable: an infinite planar wall decays by spontaneous nucleation of circular holes bounded by strings. Quite similarly, the sequence

$$G \rightarrow U(1) \rightarrow I , \quad (1.3)$$

with $\pi_2(G) = \pi_1(G) = I$ leads to formation of monopoles which get connected by strings. The strings formed at the second phase transition are metastable and decay by nucleation of monopole-antimonopole pairs.

These observations are not new. Indeed, the decay rate of a metastable string was estimated in Ref. [7], and the decay rate of a metastable wall was estimated in Ref. [5], assuming that the thickness of the defects can be neglected. Our intent is to discuss such tunneling phenomena in a fairly comprehensive way. In various cases, we describe the instanton (or "bounce") corresponding to the decay, and estimate the tunneling action. While some of our calculations merely rederive familiar results, we also present a number of new results. We consider defects in $D = 1, 2,$ and 3 spatial dimensions, and discuss the connection between tunneling phenomena in different dimensions. (Some of these lower-dimensional defects may have applications to condensed matter physics.) We em-

*On leave from Tufts University, Medford, MA 02155.

phasize in particular the differences between defects arising from gauge and global symmetries. Because global defects have long-range interactions mediated by massless Nambu-Goldstone bosons, the decay of a global defect is typically suppressed compared to the decay of its gauged counterpart.

There are also other types of metastable defects that are not associated with a hierarchy of symmetry breakdown of the form Eq. (1.1). One interesting example is global texture [2], and we discuss the decay of metastable texture in various dimensions. Another interesting case is the electroweak string [8] (or vortex), which might occur in realistic extensions of the standard model; we analyze its decay as well.

We outline a general classification of metastable defects in Sec. II, and then proceed in the remainder of the paper to discuss various special cases in more detail. Sec. III concerns defects that arise from a hierarchy of gauge symmetry breaking—monopoles, strings, domain walls, and their lower-dimensional analogues. Section IV analyzes the consequences of a hierarchy of global symmetry breaking. Metastable defects arising from the intrinsic breaking of a spontaneously broken global symmetry by a small perturbation (such as axion domain walls) are discussed in Sec. V. We consider in Sec. VI heavy metastable defects that decay to light stable defects. The decay of global texture is treated in Sec. VII. Electroweak and “semilocal” defects are discussed in Sec. VIII. Section IX contains our conclusions, including some remarks about the cosmological implications of metastable defects.

II. GENERAL THEORY

In this section, we formulate the general theory of metastable topological defects. This theory will be illuminated later by various examples.

The metastable defects that we will discuss fall into three broad categories. Those in the first category are associated with a hierarchy of (gauge or global) symmetry breakdown. Those in the second category with the intrinsic breaking of a global symmetry by a small perturbation. Those in the third category do not fit into either of the first two categories—they are classically stable but are not prevented from decaying by any topological conservation law. (Examples include global texture and electroweak vortices.)

A. Hierarchy of symmetry breakdown

Let us first consider models with a sequence of phase transitions:

$$G \rightarrow H_1 \rightarrow H_2 . \quad (2.1)$$

Here G is a finite-dimensional compact Lie group that we may take to be connected. It may be either a global symmetry group or a gauge group. (The distinction between global and gauge symmetry will be discussed later.) The G symmetry breaks to the subgroup H_1 at the mass scale η_1 , and then breaks further to $H_2 \subset H_1$ at the much lower mass scale η_2 . We wish to address whether topological

defects associated with the second stage of symmetry breakdown remain topologically stable when H_1 is embedded in G , and also the closely related but somewhat different question whether topological defects produced in the first stage survive when the second symmetry breakdown occurs.

1. Codimension 1

By a codimension 1 defect we mean one of dimension $D - 1$ in D spatial dimensions—it is a domain wall, or, in $D = 1$, a particle or “kink.” Topologically stable codimension 1 defects exist if the vacuum manifold is disconnected. Thus, if the symmetry group H_1 breaks to H_2 (and assuming no accidental degeneracy), these defects are classified by the homotopy group $\pi_0(H_1/H_2)$. But if H_1 is actually embedded in a larger symmetry group G that breaks at a much larger mass scale, then this defect may not be absolutely stable (although it is very long-lived). The domain wall separates two regions in which the order parameter takes values in two distinct connected components of H_1/H_2 . If these components are connected in the larger manifold G/H_2 , then the domain wall is metastable. Mathematically, since H_1/H_2 is included in G/H_2 , there is a natural homomorphism

$$\pi_0(H_1/H_2) \rightarrow \pi_0(G/H_2) . \quad (2.2)$$

Metastable defects of codimension 1 are classified by the nontrivial elements of the kernel of this homomorphism.

Associated with each nontrivial element of this kernel, there is a path in G that begins at the identity and ends at an element of H_1 that is not connected to the identity in H_1 . This path defines a representative of a nontrivial element homotopy class in $\pi_1(G/H_1)$. Associated with this class there is a string or vortex that arises in the symmetry breakdown $G \rightarrow H_1$. The physical interpretation is that the metastable codimension 1 defect can end on a codimension 2 defect.

2. Codimension 2

A codimension 2 defect is a “string”, or, in $D = 2$, a particle or “vortex.” By reasoning analogous to that above, metastable defects of codimension 2 are classified by the nontrivial elements of the kernel of the homomorphism:

$$\pi_1(H_1/H_2) \rightarrow \pi_1(G/H_2) . \quad (2.3)$$

Associated with each nontrivial element of the kernel, there is a noncontractible closed loop in H_1 that can be deformed to a point in G . This deformation of the loop defines a nontrivial element of

$$\pi_2(G/H_1) = \pi_1(H_1)/\pi_1(G) . \quad (2.4)$$

Associated with this element is a magnetic monopole that arises when G breaks to H_1 . The physical interpretation is that the metastable codimension 2 defect can end on a codimension 3 defect [8a].

3. Codimension 3

A codimension 3 defect is a “monopole,” a particle in $D = 3$. In principle, metastable monopoles are classified

by the nontrivial elements of the kernel of the homomorphism:

$$\pi_2(H_1/H_2) \rightarrow \pi_2(G/H_2). \quad (2.5)$$

However, this kernel is always trivial—metastable monopoles do not exist. Mathematically, this is because $\pi_2(H_1) = I$ for any finite-dimensional compact Lie group H_1 . [Note that metastable domain walls are associated with nontrivial elements of $\pi_0(H_1)$, and metastable strings are associated with nontrivial elements of $\pi_1(H_1)$.]

We can express this result in more physical terms in the case where G is a gauge symmetry. Then the magnetic monopole that arises when H_1 breaks to H_2 carries a conserved magnetic charge, which can be detected by measuring the long-range H_2 magnetic field of the monopole. Embedding H_1 in G does not extinguish that long-range field, or destroy the conservation law—the monopole remains absolutely stable. (Although quantum effects, specifically color confinement, may cause the magnetic field to be screened, these effects do not prevent the charge from being detected at long range, and do not destroy the conservation law [9,10].)

B. Comments

1. Bianchi identity

We could also consider a more intricate symmetry breaking hierarchy of the form

$$G \rightarrow H_1 \rightarrow H_2 \rightarrow H_3. \quad (2.6)$$

One might then wonder if it is possible for a monopole to arise when G breaks to H_1 such that the monopole becomes attached to a string when H_1 breaks to H_2 , and the string in turn becomes attached to a wall when H_2 breaks to H_3 . It is easy to see that this is not possible. This conclusion is probably best understood as a consequence of the Bianchi identity—“the boundary of a boundary is zero.” If a string is the boundary of a domain wall, then the string cannot end (on a monopole). In terms of the above homotopy classification, we saw that there are two types of strings that can arise when H_1 breaks to H_2 . A string that ends on a monopole is associated with a noncontractible closed path in H_1 , while a string that bounds a domain wall is associated with an open path in H_1 that begins at the identity and ends at an element of H_2 that is not connected to the identity in H_2 .

Another observation is closely related to the above: It is impossible for a string that ends on a monopole to have nontrivial Aharonov-Bohm interactions that can detect the “quantum hair” [11] of charged particles. Strings that detect quantum hair carry a magnetic flux that does not lie in the connected component of the unbroken group H_2 ; they are the kind of strings that can bound domain walls, not the kind that can end on monopoles [12,13]. This is not to say that the Aharonov-Bohm interactions of strings that end on monopoles must be completely trivial; rather, the group element that characterizes the flux trapped in the core of the string must be connected to the identity in H_2 . An example of a string that

ends on a monopole, yet has nontrivial Aharonov-Bohm interactions, is the electroweak string that we will discuss in Sec. VIII [8,14].

2. Bundles

The analysis in Sec. II A above can be reexpressed in the language of fiber bundles. When the symmetry-breaking pattern (2.1) occurs, we may view the vacuum manifold G/H_2 as the total space of a bundle with base space G/H_1 , fiber H_1/H_2 , and structure group H_1 . Then the topological defects arising in the first stage of the symmetry breakdown are determined by the topology of the base space, and the defects arising in the second stage are determined by the topology of the fiber. Our criterion for a codimension $n + 1$ defect to be metastable, then, is that a mapping that represents a nontrivial element of π_n of the fiber is topologically trivial in the total space of the bundle.

3. Survival

We may also ask a slightly different question than that formulated in Sec. II A above. If a defect arises when G breaks to H_1 , will that defect “survive” if the symmetry breaks further, to H_2 ? Before, we found the criterion for a monopole to become attached to a single string, or for a string to become attached to a single wall. Now we are asking a more general question, because it is also possible for a monopole to become attached to more than one string, or for a string to become attached to more than one wall.

The criterion for a defect to survive is most simply stated in the fiber bundle language. A codimension $n + 1$ topological defect that arises when G breaks to H_1 is associated with a nontrivial element of π_n of the base space of the bundle. The defect survives if this element can be “lifted” to π_n of the total space of the bundle. That is, the bundle comes equipped with a projection map $\phi: G/H_2 \rightarrow G/H_1$, and the defect is characterized by a topologically nontrivial map $f: S^n \rightarrow G/H_1$. The defect survives if there is a continuous map $\tilde{f}: S^n \rightarrow G/H_2$ such that $f = \phi \circ \tilde{f}$.

Domain walls always survive, but strings and monopoles need not. Note that it is possible for a monopole to be attached to two (or more) strings where one string is heavy and the other is light. In $D = 2$, then, the monopole mediates the decay of a heavy vortex to a light vortex (or several light vortices). If two degenerate strings end on a monopole [15], then in $D = 2$ the monopole is an instanton that allows two degenerate vortices to mix quantum mechanically. Similarly, a string could be attached to a heavy wall and a light wall. Then, in $D = 1$, the vortex mediates the decay of a heavy kink to a light kink. If two degenerate walls end on a string, then in $D = 1$ the vortex allows degenerate kinks to mix.

C. Intrinsic symmetry breaking

Another type of metastable defect can arise when an approximate global symmetry is spontaneously broken. Consider the pattern

$$\begin{array}{ccc}
G_{\text{approx}} & \rightarrow & H_{\text{approx}} \\
\cup & & \cup \\
G_{\text{exact}} & \rightarrow & H_{\text{exact}}
\end{array} \quad (2.7)$$

That is, G_{approx} is spontaneously broken to H_{approx} , and is also intrinsically broken by a small perturbation to G_{exact} . (Thus G_{approx} must be a global symmetry group; gauge symmetries are always exact.) The unbroken exact symmetry is H_{exact} , the intersection of G_{exact} and H_{approx} .

If we ignore the intrinsic symmetry breaking, then topological defects of codimension $n+1$ are classified by $\pi_n(G_{\text{approx}}/H_{\text{approx}})$. We may ask if such a defect can “survive” when the intrinsic symmetry breakdown is taken into account. The criterion for survival can be expressed in the following way. The defect is associated with a topologically nontrivial map from S^n to the approximate vacuum manifold $G_{\text{approx}}/H_{\text{approx}}$. The defect survives if this mapping can be continuously deformed to one that takes values in the exact vacuum manifold $G_{\text{exact}}/H_{\text{exact}}$.

If a $G_{\text{approx}}/H_{\text{approx}}$ domain wall does not survive, then the energy densities on the two sides of the wall are unequal, and a resulting pressure pushes the wall away. If a $G_{\text{approx}}/H_{\text{approx}}$ string does not survive, then it becomes attached to one or more walls; if the number of walls is exactly 1, then there is a metastable wall that can end on a loop of string. If a $G_{\text{approx}}/H_{\text{approx}}$ (global) monopole does not survive, then it becomes attached to one or more strings; if the number of strings is exactly 1, there is a metastable string that can break by nucleating a monopole pair.

The most familiar example of this phenomenon is the axion string, which becomes attached to N axion domain walls [16–18]. Thus, if $N=1$, an axion domain wall is metastable and can decay by nucleating a loop of axion string. In $D=1$, the axion vortex mediates the decay of an axion kink.

D. Other cases

There are a few interesting classes of metastable defects that do not arise due to a hierarchy of symmetry breakdown, or because of intrinsic symmetry breaking. These defects are classically stable, but are not forbidden to decay quantum mechanically.

1. Global texture

If a global symmetry G is spontaneously broken to H , then a global texture (or “Skyrmion”) is a field configuration that takes values in (or near) the vacuum manifold G/H everywhere. (There is no “restoration” of the spontaneously broken symmetry in its core.) Such configurations, if they have finite energy, are classified in D spatial dimensions by $\pi_D(G/H)$ [2]. A texture has only gradient energy, and for $D \geq 3$, the gradient energy makes it want to collapse. But it can be stabilized if suitable higher derivatives terms [19] are introduced into the action (or if a *subgroup* of G is gauged [20]).

For $D=1$, its gradient energy makes a texture want to spread out. It can be stabilized if space is compactified to

a circle of finite circumference.

Unlike a kink in one dimension, a (gauge) vortex in two dimensions, or a (gauge) monopole in three dimensions, a global texture in D dimensions is not separated from the vacuum by an infinite energy barrier. Thus, even if it is classically stable, there is no topological conservation law that prevents it from decaying quantum mechanically.

Indeed, in any model that contains a D -dimensional global texture, there is also a “global instanton” that mediates the decay of the texture. This instanton is also classified by $\pi_D(G/H)$; it is a pointlike defect in $(D+1)$ -dimensional Euclidean spacetime, with the world line of a texture ending on the instanton. We will discuss texture decay in more detail in Sec. VII.

2. Semilocal and electroweak strings

“Semilocal” strings [21] (or vortices) can arise in models that have both gauge and global symmetries that are spontaneously broken, but only if the symmetries “mix;” that is, there must be unbroken global symmetry generators that are nontrivial linear combinations of spontaneously broken gauge symmetry generators and global symmetry generators.

Consider the pattern

$$\begin{array}{ccc}
G_1 \times G_2 & \rightarrow & H \\
\cup & & \cup \\
G_1 & \rightarrow & H_1
\end{array} \quad (2.8)$$

Here G_1 is the gauge group and G_2 is a global symmetry group. H_1 is the unbroken gauge group, the intersection of G_1 and H . In this scheme, for $D=2$, there is a topologically conserved magnetic flux that is classified by $\pi_1(G_1/H_1)$, and a natural homomorphism

$$\pi_1(G_1/H_1) \rightarrow \pi_1([G_1 \times G_2]/H). \quad (2.9)$$

If this homomorphism has a nontrivial kernel (which is possible only if G_1 and G_2 mix [14]), then there are field configurations that carry nontrivial G_1/H_1 magnetic flux, where the order parameter takes values in the vacuum manifold $[G_1 \times G_2]/H$ everywhere.

When such configurations exist, it becomes a dynamical question whether the energy in a given magnetic flux sector is minimized by a localized vortex or by a configuration in which the magnetic flux is spread out over an arbitrarily large area. The answer depends on the details of the Higgs potential.

In some models, there may be vortices that are classically stable, but are kinematically allowed to decay to configurations in which the magnetic flux is spread out. Then the decay is mediated by a global monopole [22,20,14], as we will describe in more detail in Sec. VIII. Similarly, for $D=3$, there may be string that can decay via the nucleation of a global monopole pair.

The simplest example of the semilocal phenomenon is the case $G_1=U(1)$, $G_2=SU(2)$, and $H=U(1)$, which may be regarded as the minimal standard electroweak model in the limit $\sin^2\theta_W=1$.

It is also interesting to consider a semilocal model in which the vortex is stable, and ask what would happen if

G_2 were gauged. Then the vortex no longer carries any conserved topological charge, and will surely decay. But if the G_2 gauge coupling is sufficiently weak, one expects the vortex to remain *classically* stable [8]. Thus, the vortex is metastable, and its decay is mediated by a magnetic monopole, as we will explain in Sec. VIII. Similarly, for $D=3$, there is a metastable string that decays by nucleating a monopole pair. Because such a metastable string arises in the minimal standard model, for an (unrealistic [23]) range of values of $\sin^2\theta_W$ and the Higgs-boson mass, we refer to it as an “electroweak string.”

III. GAUGE HIERARCHY

We will now discuss in more detail the decay of metastable defects in a model with the pattern of *gauge* symmetry breaking (2.1).

A. Codimension 2

1. $D=3$

We first consider the decay of metastable gauge strings in three dimensions. If the string can break due to the nucleation of a monopole-antimonopole pair, then there will be a nonzero probability of decay per unit length and time. A long straight string with string tension μ will tunnel to a configuration of the same energy, in which there is a gap in the string of length L , with a monopole at rest at each end. The energy cost of producing the pair is $2m$, where m is the monopole mass; this cost must be balanced by the energy μL saved due to the reduction in the string length. Thus, the initial separation of the monopole and antimonopole is $L=2m/\mu$. The monopoles subsequently pull apart, consuming the string. Since the width of the barrier is L and its height is $2m$, we can crudely estimate that the decay probability will be of the form $P\sim e^{-B}$, where the WKB tunneling factor is of order m^2/μ (in units with $\hbar=1$).

To calculate the semiclassical tunneling factor more precisely, it is most convenient to use the Euclidean path integral method [24]. The decay is described by an instanton (or “bounce”), which is a solution of Euclidean (imaginary time, $t=-i\tau$) field equations approaching the unperturbed string solution at $\tau\rightarrow\pm\infty$. The origin of τ can be chosen so that the instanton is symmetric with respect to $\tau\rightarrow-\tau$. Then the instanton solution at $\tau=0$ gives the field configuration at the moment of nucleation of the monopole-antimonopole pair. The semiclassical decay probability is

$$P\propto e^{-B}, \quad (3.1)$$

where

$$B=S-S_0, \quad (3.2)$$

is the difference between the Euclidean actions of the instanton (S) and of the unperturbed string (S_0).

In the four-dimensional language, the string axis is represented by a two-dimensional world sheet, and the monopole center by a one-dimensional world line. A

static straight string oriented along the z axis corresponds to a planar world sheet, $x=y=0$; in the instanton solution this world sheet has a “hole” which is bounded by the closed world line of the monopole (see Fig. 1). In relativistic field theories, the string is invariant with respect to Lorentz boosts in the z direction, which turn into $z-\tau$ rotations after the change $t\rightarrow-i\tau$. The bounce solution preserves this symmetry; the monopole world line is a circle in the $z-\tau$ plane. In the rest of this paper we shall assume relativistic invariance, although our results can be easily generalized to the nonrelativistic case.

The planar string world sheet with a circular hole bounded by the monopole world line can be thought of as a domain wall bounded by a string in four spatial dimensions. Indeed, the conditions for the existence of planar and linear defects in four dimensions are, respectively, $\pi_1(M)\neq I$ and $\pi_2(M)\neq I$. From this point of view, our instanton is a time-independent solution of (4+1)-dimensional field equations describing a planar “wall” with a circular hole bounded by a “string” in a state of unstable equilibrium. If the “string” radius is decreased, the hole begins to shrink, and if it is increased, it starts growing. The bounce solution must have such a negative mode, according to general arguments [25].

If the radius of the monopole world line is much greater than the string thickness, $R\gg\delta_s$, we can use the thin-string and thin-monopole approximation, in which the actions for the monopole and for the string are proportional to the world line length and world sheet area, respectively:

$$S=m\int ds+\mu\int dS_2. \quad (3.3)$$

For our instantons, the bounce action (3.2) is

$$B=2\pi Rm-\pi R^2\mu. \quad (3.4)$$

This expression is stationary with respect to R for

$$R=m/\mu, \quad (3.5)$$

$$B=\pi m^2/\mu. \quad (3.6)$$

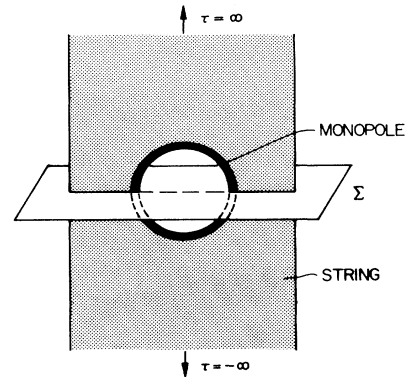

FIG. 1. Instanton describing the decay of a metastable string, with one dimension suppressed. The field configuration in the hyperplane Σ corresponds to the moment of nucleation of the monopole-antimonopole pair.

Hence, the initial separation of the monopole-antimonopole pair is $2m/\mu$, as we anticipated, and the nucleation probability is $P \propto \exp(-\pi m^2/\mu)$, in agreement with [7].

The thin-defect approximation is justified if

$$m/\mu \gg \delta_s. \quad (3.7)$$

This condition is typically satisfied if the symmetry breaking scale of monopoles is much greater than that of the strings, $\eta_1 \gg \eta_2$. Exceptions to this rule can occur if Higgs or gauge couplings of the model are very small. For $R \lesssim \delta_s$, the bounce action depends on the details of the model, and no simple estimate can be given in the general case.

2. $D=2$

In two spatial dimensions, models such as (1.3) give rise to metastable vortices. The vortex can tunnel to a configuration of the same energy, and about the same core size. This configuration has a nonzero magnetic field, but its total magnetic flux is trivial. Thus, there is nothing to prevent the configuration from subsequently relaxing to the vacuum.

The instanton in this case is a monopole-antimonopole pair in unstable equilibrium in three Euclidean dimensions. The Coulombic attraction between the monopole and antimonopole is balanced by the tension of the strings pulling in opposite directions (see Fig. 2). The theory must have a solution of this form, since we know that models of the type (1.3) give monopoles connected by strings in three dimensions. The midsection of the instanton (surface Σ in Fig. 2) gives the field configuration of the decaying vortex right after the tunneling.

The bounce action can be roughly estimated as

$$B \sim 2m - \frac{1}{e^2 R} - \mu R, \quad (3.8)$$

where m is the monopole mass, the second term is the Coulombic energy of the pair, and the last term is the energy of the missing piece of string. This expression is sta-

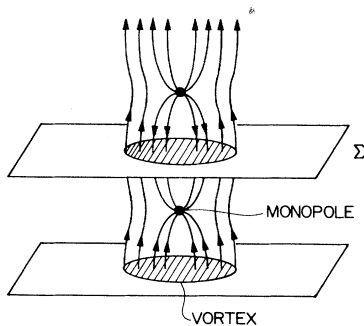

FIG. 2. Instanton for the decay of a metastable vortex is a monopole-antimonopole pair in unstable equilibrium inside a string. The magnetic field pattern in a plane containing the monopoles is shown. Shading indicates the area containing most of the magnetic flux in the string cross section.

tionary for $R \sim e^{-1}\mu^{-1/2} \sim \delta_s$, where δ_s is the string thickness. Equation (3.8) is only a rough estimate because R is comparable to the thickness of the string; therefore, the Coulomb interaction between the monopoles is significantly distorted by the string. The last two terms in (3.8) are both of the order $e^{-1}\mu^{1/2}$ and are negligible compared to the first term if the symmetry breaking scale of the monopoles is much greater than that of strings. Hence,

$$B \approx 2m. \quad (3.9)$$

Recall that the “mass” of the monopole actually has the dimensions of action in $D=2$ (in units with $c=1$). In order of magnitude it is $m \sim 4\pi\eta_1/e$, where η_1 is the expectation value of a scalar field; η_1 has the dimensions of (energy) $^{1/2}$, and e^{-1} has the dimensions of (energy) $^{1/2}$ (length), in two spatial dimensions.

For $\eta_1 \gg \eta_2$, the effects on the vortex of the physics at energy scale η_1^2 can be conveniently incorporated into an effective Lagrangian [12]. Were we to ignore the heavy magnetic monopole, the low-energy effective theory would have an exact topological conservation law that would ensure that the vortex is absolutely stable. But when the monopole instantons are integrated out, operators are induced in the effective Lagrangian that violate this conservation law. Specifically, an operator appears that annihilates (or creates) a vortex, with a coefficient that is proportional to e^{-m} . Calculating with this effective Lagrangian, we again find a vortex decay rate of order e^{-2m} .

B. Codimension 1

1. $D=3$

The decay of metastable domain walls can be analyzed in a similar way. If the wall can herniate by nucleating a loop of string, then there will be a nonzero decay probability per unit time and area [5]. A planar wall will tunnel to a configuration of the same energy, with a circular hole in the wall bounded by the string loop. The radius of the hole is chosen so that the energy cost of the string loop matches the energy saved due to the missing wall. The string loop appears at rest, and then expands, consuming the wall.

Again, we compute the tunneling action using the Euclidean path-integral method. In the thin-defect approximation, the action is

$$S = \mu \int dS_2 + \sigma \int dS_3, \quad (3.10)$$

where μ and σ are string and wall tensions, respectively. In the instanton solution, the wall world membrane is a three-dimensional hyperplane with a spherical hole bounded by the string world sheet. The bounce action is then

$$B = 4\pi R^2 \mu - \frac{4\pi}{3} R^3 \sigma, \quad (3.11)$$

which is stationary with respect to R for [5]

$$R = 2\mu/\sigma, \quad (3.12)$$

$$B = \frac{16\pi\mu^3}{3\sigma^2}. \quad (3.13)$$

2. $D=2$

In two spatial dimensions, models such as (1.2) give rise to metastable linear defects which decay by nucleation of vortex-antivortex pairs. The decay is described by Eqs. (3.3)–(3.6), where now m stands for the vortex mass and μ for the tension of the linear defects.

3. $D=1$

In one spatial dimension, the domain wall becomes a particle, or “kink.” Were it not for the existence of vortices, the kink would carry a conserved topological quantum number, and would be stable. But the vortices enable the kink to decay.

The instanton describing the kink decay is a vortex-antivortex pair, in two Euclidean dimensions, in which the attraction between the vortex and antivortex is balanced by the tension of linear defects (“walls”) attached to the vortices. An argument similar to the one that led to Eq. (3.9) gives

$$B \approx 2\mu, \quad (3.14)$$

for the case when the first symmetry breaking scale is much greater than the second. Here μ is the vortex action and is given by the same expression as the string tension in the corresponding (3+1)-dimensional theory.

The kink decays to what might be called a gauge texture, a configuration that matches the asymptotic behavior of the kink, but in which the Higgs field is a pure gauge that has a nontrivial winding around G/H_1 . This configuration has a different [(1+1)-dimensional] “Chern-Simons number” than the kink. The change in the Chern-Simons number is provided by the vortex instanton.

Again, the violation of the topological conservation law can be incorporated into an effective Lagrangian. Integrating out vortices induces an operator that destroys (or creates) a kink, with a coefficient proportional to $e^{-\mu}$.

IV. GLOBAL HIERARCHY

In the case of global symmetry breaking, the instantons still represent unstable equilibrium configurations of higher-dimensional defects, but there is an important difference. Global defects have long-range interactions mediated by massless Nambu-Goldstone bosons. This leads to an increase in the height of the potential barrier and to a strong suppression of the decay. Moreover, since the dominant part of the energy of global defects is located outside the core, the thin-defect approximation can no longer be used, and the field configuration of the instanton has to be studied in some more detail.

A. Codimension 1

A simple example of a model with metastable domain walls or kinks is

$$L = |\partial_\mu \varphi_1|^2 + |\partial_\mu \varphi_2|^2 - V(\varphi_1, \varphi_2), \quad (4.1)$$

where φ_1 and φ_2 are complex scalar fields and

$$V(\varphi_1, \varphi_2) = \lambda_1(|\varphi_1|^2 - \eta_1^2)^2 + \lambda_2(|\varphi_2|^2 - \eta_2^2)^2 - \lambda_{12}\eta_1(\varphi_1\varphi_2^2 + \text{H.c.}). \quad (4.2)$$

This model, for $\eta_1 \gg \eta_2$, realizes Eq. (1.2) as a hierarchy of *global* symmetry breaking, with $G = \text{U}(1)$.

Without the last term in the potential, the model would have a $\text{U}(1) \times \text{U}(1)$ symmetry and $V(\varphi)$ would be minimized by

$$\varphi_1 = \eta_1 e^{i\theta_1}, \quad \varphi_2 = \eta_2 e^{i\theta_2}, \quad (4.3)$$

with arbitrary θ_1 and θ_2 . But the last term breaks the symmetry to $\text{U}(1)$, and fixes the value of $\theta_1 + 2\theta_2$. To simplify the analysis, we shall assume that λ_{12} is sufficiently small that it does not affect the magnitudes of the expectation values (4.3). (Specifically, one needs $\lambda_1\eta_1^2 \gg \lambda_{12}\eta_2^2$, $\lambda_2\eta_2^2 \gg \lambda_{12}\eta_1^2$.) Then the effective Lagrangian for the angular variables θ_1 and θ_2 is

$$L_\theta = \eta_1^2(\partial_\mu \theta_1)^2 + \eta_2^2(\partial_\mu \theta_2)^2 + 2\lambda_{12}\eta_1^2\eta_2^2 \cos(\theta_1 + 2\theta_2). \quad (4.4)$$

We can diagonalize this Lagrangian by introducing the new variables $\bar{\theta}_1$ and $\bar{\theta}_2$:

$$\theta_1 = -\bar{\theta}_1 + \frac{\eta_2^2}{2\eta_1^2}\bar{\theta}_2, \quad \theta_2 = \bar{\theta}_2 + \frac{1}{2}\bar{\theta}_1. \quad (4.5)$$

Then, to leading order in η_1/η_2 we have $\theta_1 + 2\theta_2 = 2\bar{\theta}_2$ and

$$L_\theta = \eta_1^2(\partial_\mu \bar{\theta}_1)^2 + \eta_2^2(\partial_\mu \bar{\theta}_2)^2 + \frac{1}{2}m^2\eta_2^2 \cos 2\bar{\theta}_2, \quad (4.6)$$

where $m^2 = 4\lambda_{12}\eta_1^2$. The field $\bar{\theta}_1$ is a massless Nambu-Goldstone field resulting from the breaking of the global symmetry $\theta_1 \rightarrow \theta_1 + 2\alpha$, $\theta_2 \rightarrow \theta_2 - \alpha$, while the field $\bar{\theta}_2$ is described by a sine-Gordon Lagrangian. The potential for $\bar{\theta}_2$ is minimized when $\bar{\theta}_2 = n\pi$ ($n = \text{integer}$), and the kink solution that interpolates between, say, $\bar{\theta}_2 = 0$ and $\bar{\theta}_2 = \pi$ is

$$\bar{\theta}_2(x) = 2 \arctan \exp(mx). \quad (4.7)$$

The energy of the kink (or tension in the wall) is

$$\sigma = 4\eta_2^2 m. \quad (4.8)$$

1. $D=1$

In estimating the decay rates, we will start with the case of the kink in one dimension, and then work our way up to $D=3$.

In the kink solution, θ_2 rotates with θ_1 held fixed. The kink can tunnel to a configuration with the same asymptotic behavior and the same energy, in which θ_2 and θ_1

rotate together. This configuration has gradient energy, but no potential energy, so nothing prevents it from spreading, and relaxing to a configuration in which θ_1 and θ_2 are nearly constant.

If, after tunneling, the region in which θ_1 twists is of length L , then the gradient energy is of order η_1^2/L . This configuration will be degenerate with the kink for $L \sim \eta_1^2/\sigma$.

To analyze the tunneling more precisely, and compute the tunneling action, we use the Euclidean path-integral method. The instanton describing the kink decay is an unstable defect configuration in two Euclidean dimensions. The two-dimensional theory with the Lagrangian (4.1), (4.2) has vortex solutions in which the phase θ_1 changes by 2π around the vortex. The potential in (4.4) is minimized by setting $\theta_2 = -\theta_1/2$, but then the change of θ_2 around the vortex is only π , and thus the vortex should be attached to a linear defect (a “wall”). The cross section of the “wall” is identical to the kink (4.7) and its tension is given by (4.8). The instanton describing the kink decay consists of a vortex-antivortex pair held apart by two “walls.” Outside the “walls,” θ_1 is well approximated by $\theta_1 = \phi_1 + \phi_2$, where ϕ_1 and ϕ_2 are azimuthal angles defined in Fig. 3. The corresponding pattern for θ_2 near the “walls” and on the midsection Σ is sketched in Fig. 4. The action for this instanton is

$$B = 4\pi\eta_1^2 \ln(R/\delta_s) - \sigma R ; \quad (4.9)$$

here the first term is twice the energy μ of a vortex:

$$\mu = \eta_1^2 \int_{\delta_s}^R (\nabla\theta_1)^2 2\pi r dr \approx 2\pi\eta_1^2 \ln(R/\delta_s) , \quad (4.10)$$

$\delta_s \sim \lambda_1^{-1/2} \eta_1^{-1}$ is the size of the vortex core and R is the vortex-antivortex separation. Since the R dependence of μ is only logarithmic, the result is not sensitive to whether we choose R or, say, $R/2$ as a cutoff in (4.10). The second term in (4.9) is the energy of the missing “wall.” Eq. (4.9) is stationary for

$$R = 4\pi\eta_1^2/\sigma \quad (4.11)$$

and

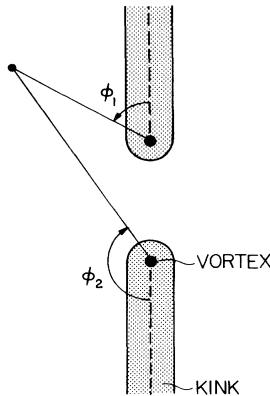

FIG. 3. Instanton for the decay of a global kink. The angles ϕ_1 and ϕ_2 are defined as shown, with branch cuts at the centers of the “walls.” The shaded region is the interior of the kink, where $\bar{\theta}_2 \approx \theta_2 + \theta_1/2$ is substantially different from 0 or π .

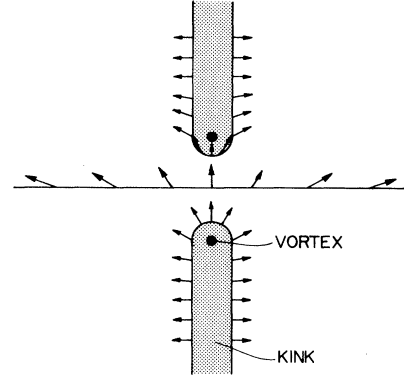

FIG. 4. Instanton for the decay of a global kink. The directions of arrows indicate the value of θ_2 .

$$B \approx 4\pi\eta_1^2 \ln \left[\frac{\eta_1^3 \lambda_1^{1/2}}{\sigma} \right] \approx 2\pi\eta_1^2 \ln \left[\frac{\lambda_1 \eta_1^4}{\lambda_{12} \eta_2^4} \right] . \quad (4.12)$$

Note that with $\eta_1 \gg \eta_2$, R is much greater than the “wall” thickness, $\delta_w \sim m^{-1}$. This justifies the thin-wall approximation in (4.9).

2. $D=2$

In two spatial dimensions, the model (4.1), (4.2) gives rise to metastable linear defects. The instanton describing their decay consists of a planar “wall” with a circular hole bounded by a global string in three Euclidean dimensions. Assuming that $R \gg \delta_w$, the bounce action can be written as

$$B \approx 2\pi R 2\pi\eta_1^2 \ln(R/\delta_s) - \pi R^2 \sigma , \quad (4.13)$$

which is stationary for

$$\sigma R \approx 2\pi\eta_1^2 \ln(R/\delta_s) , \quad (4.14)$$

and

$$B \approx \frac{4\pi^3 \eta_1^4}{\sigma} \ln^2 \left[\frac{\eta_1^3 \lambda_1^{1/2}}{\sigma} \right] \approx \frac{\pi^3 \eta_1^3}{2\sqrt{\lambda_{12} \eta_2^2}} \ln^2 \left[\frac{\lambda_1 \eta_1^4}{\lambda_{12} \eta_2^4} \right] . \quad (4.15)$$

We note that (4.15) can be obtained from the thin-defect result [see Eq. (3.6)] using the “renormalized” global string tension (4.10).

3. $D=3$

Finally, we consider metastable global defects in three dimensions. The model (4.1), (4.2) has metastable domain walls which decay by nucleation of circular loops of string. By the same argument as before, the corresponding tunneling action is given by the thin-defect equations (3.12), (3.13) with σ from (4.8) and μ from (4.10):

$$B \approx \frac{\pi^4}{12\lambda_{12}} \left[\frac{\eta_1}{\eta_2} \right]^4 \ln^3 \left[\frac{\lambda_1 \eta_1^4}{\lambda_{12} \eta_2^4} \right]. \tag{4.16}$$

B. Codimension 2

As a simple example of a model that contains metastable global strings or vortices, consider a model with spontaneously broken SU(2) global symmetry, which has a scalar triplet φ_1 interacting with a doublet φ_2 , via the potential

$$V(\varphi_1, \varphi_2) = \lambda_1(\varphi_1^2 - \eta_1^2)^2 + \lambda_2(\varphi_2^\dagger \varphi_2 - \eta_2^2)^2 - \lambda_{12} \eta_1 \varphi_1 \varphi_2^\dagger \sigma \varphi_2. \tag{4.17}$$

For $\eta_1 \gg \eta_2$, the symmetry breaking is that of Eq. (1.3) with $G = \text{SU}(2)$.

1. D=2

In two spatial dimensions, the model (4.17) contains a metastable vortex. In the vortex solution, φ_1 is essentially a constant, which we may take to be

$$\varphi_1 = \begin{pmatrix} 0 \\ 0 \\ \eta_1 \end{pmatrix}, \tag{4.18}$$

and φ_2 has the asymptotic behavior

$$\varphi_2(r = \infty, \theta) = \eta_2 \begin{pmatrix} e^{i\theta} \\ 0 \end{pmatrix} \tag{4.19}$$

(for $\lambda_{12} > 0$).

When we consider the decay of this object, there is a subtlety, namely that the energy of an isolated vortex is divergent in an infinite volume. We should therefore imagine that the vortex is actually a member of a distantly separated vortex-antivortex pair (or that a suitable infrared cutoff has been imposed in some other way). The ‘‘mass’’ of the vortex is of order $2\pi\eta_2^2 \ln(R_{\text{cutoff}}/\delta_s)$, where R_{cutoff} is the infrared cutoff and δ_s is the size of the vortex core (of order m_2^{-1} , where m_2 is the mass of φ_2).

The vortex can tunnel to a configuration that has the same asymptotic behavior, but has negligible potential energy. In this configuration, φ_1 rotates inside a region of radius R , and the scalar fields lie close to the vacuum manifold everywhere. The gradient energy is then of order $\eta_1^2 + \eta_2^2 \ln(R_{\text{cutoff}}/R)$ (assuming that $R_{\text{cutoff}} \gg R$), so this configuration is degenerate with the vortex for $\ln(R/\delta_s) \sim \eta_1^2/\eta_2^2$.

If a vortex and antivortex are held at fixed positions, the tunneling of one of the two is kinematically forbidden unless the distance between them is truly enormous. If, say, the antivortex tunnels, the fields will eventually relax to a configuration that has a vortex core, but is trivial at spatial infinity, a configuration with a gradient energy of order η_1^2 .

We turn now to the computation of the tunneling action. In a three-dimensional space the model (4.17) has solutions describing global monopoles attached to global strings, and the instanton describing the vortex decay

consists of a monopole-antimonopole pair held apart by the string tension. The energy of this configuration diverges not only due to the infinite length of strings, but also because the energy per unit length of a global string is logarithmically divergent. However, the bounce action (3.2) can still be expected to be finite, since the monopoles do not significantly affect the field of the string at distances much greater than the monopole separation, R . Assuming that R is much larger than the thickness of the string core δ_s , we can write the bounce action as

$$B \approx 4\pi\eta_1^2 R - 2\pi\eta_2^2 R \ln(R/\delta_s). \tag{4.20}$$

The first term in (4.20) is the monopole energy, and the second is the energy of the missing part of the string.

Equation (4.20) is stationary for

$$4\pi\eta_1^2 \approx 2\pi\eta_2^2 \left[\ln \frac{R}{\delta_s} + 1 \right], \tag{4.21}$$

$$R \approx \delta_s \exp \left[\frac{2\eta_1^2}{\eta_2^2} \right], \tag{4.22}$$

and

$$B \approx 2\pi\eta_2^2 \delta_s \exp \left[\frac{2\eta_1^2}{\eta_2^2} \right]. \tag{4.23}$$

For $\eta_1 \gg \eta_2$ this action is exponentially large, and thus the decay of global vortices is very strongly suppressed. The value of the prefactor in front of the exponential term in Eq. (4.23) should not be taken seriously; this prefactor is difficult to estimate because it is sensitive to terms, subleading in R , that have been omitted from Eq. (4.20). To determine the prefactor more accurately, one would have to solve the field equations for the instanton.

We see that if a vortex and antivortex are held at fixed positions, with separation R_{pair} , the tunneling rate remains finite as R_{pair} approaches infinity (while the interaction energy of the pair diverges). There is of course a competing process, in which the vortex and antivortex *annihilate* due to tunneling. This is the dominant tunneling process for $R_{\text{pair}} \ll R$ [with R as in Eq. (4.22)], but is strongly suppressed for $R_{\text{pair}} \gg R$.

2. D=3

Metastable global strings of the model (4.17) decay by nucleation of monopole-antimonopole pairs. Again, the energy per unit length of a global string is infrared divergent, so we should consider a very long (but finite) string loop, or impose an infrared cutoff in some other suitable way.

A global monopole and antimonopole attract one another with a force $4\pi\eta_1^2$ that is independent of their separation. Thus, it is not so easy to pay back the energy cost of nucleating the pair by pulling the monopole and antimonopole apart. In fact, it is just the logarithmic infrared divergence in the tension of the global string that makes the tunneling possible—the energy saved by reducing the string length by L is enhanced by a factor of $\ln L$ relative to the energy cost of producing a monopole pair with separation L .

The instanton in this case is a planar defect in four dimensions, with a circular hole bounded by a linear defect (representing the monopole world line). The tunneling action is

$$B \approx 4\pi\eta_1^2\pi R^2 - 2\pi\eta_2^2\pi R^2 \ln(R/\delta_s), \quad (4.24)$$

which is stationary with respect to R for

$$R \approx \delta_s \exp\left[\frac{2\eta_1^2}{\eta_2^2}\right], \quad (4.25)$$

$$B \approx \pi^2\eta_2^2\delta_s^2 \exp\left[\frac{4\eta_1^2}{\eta_2^2}\right]. \quad (4.26)$$

With $\eta_1 \gg \eta_2$, B is typically very large, and the strings are essentially stable. [Again, the estimate of the prefactor in front of the exponential term in Eq. (4.26) should not be considered reliable.]

If a finite string loop of radius R_{loop} is held in a fixed position, then, as in our discussion of vortex decay, there is a competing process in which the loop annihilates instead of breaking. But the action for this process is proportional to R_{loop}^2 ; it is subdominant for $R_{\text{loop}} \gg R$ [with R given by Eq. (4.25)].

V. INTRINSIC SYMMETRY BREAKING

As noted in Sec. II C, a defect associated with a spontaneously broken global symmetry may fail to “survive” when the symmetry is intrinsically broken by a small perturbation. When a defect of codimension $n+1$ does not survive, it becomes attached to one or more defects of codimension n . If the number of codimension n defects attached to the codimension $n+1$ defect is exactly 1, then the codimension n defect is metastable, and can decay by nucleating a codimension $n+1$ defect. In this section, we illustrate this phenomenon with a few examples.

A. Codimension 1

Consider the case, in the notation of Eq. (2.7), $G_{\text{approx}} = \text{U}(1) \rightarrow H_{\text{approx}} = I$, $G_{\text{exact}} = \text{Z}_N$. Suppose that, when we ignore the intrinsic symmetry breaking, the $\text{U}(1)$ symmetry is spontaneously broken by the condensation of a complex scalar field:

$$\langle \varphi \rangle = \eta e^{i\theta} \quad (5.1)$$

(where the phase θ is arbitrary). This model contains a global string, such that θ advances by 2π on a large circle that encloses the string core.

When we introduce the symmetry-breaking perturbation; however, there are N degenerate vacuum states, with

$$\langle \varphi \rangle = \eta e^{2\pi i k / N}, \quad k = 0, 1, 2, \dots, N-1. \quad (5.2)$$

Hence, the string does not “survive.” On a circle surrounding the string core, θ will choose to stay close to the vacuum manifold $\theta = 2\pi k / N$, except at isolated points where θ abruptly jumps from one vacuum value to the next. Thus, the string becomes attached to N domain walls [17]. (Conceivably, these walls will attract each

other, so that in the configuration of minimal energy θ jumps by 2π all in one step. Then the string is attached to a single metastable wall.)

The walls have a thickness of order m_a^{-1} , where m_a is the mass of the $\text{U}(1)$ pseudo Goldstone boson (the “axion”). The string tension μ and the wall tension σ are, in order of magnitude,

$$\mu \sim 2\pi\eta^2 \ln(1/m_a\delta_s), \quad \sigma \sim \eta^2 m_a, \quad (5.3)$$

where δ_s is the thickness of the string core.

Note that this precise pattern of symmetry breaking occurs in models that solve the strong CP problem by the Peccei-Quinn mechanism [26,27], where $\text{U}(1)$ is the Peccei-Quinn symmetry, and the intrinsic symmetry breaking is due to QCD.

In the discussion below, we assume that $N=1$, so that a single “axion domain wall” ends on the “axion string.”

1. $D=1$

In one spatial dimension, this model has a metastable axion “kink.” We can anticipate that this kink, with width of order m_a^{-1} , will decay by tunneling to an “unwound” configuration of about the same size.

As in Sec. IV A 1, the bounce solution is a vortex-antivortex pair in unstable equilibrium, with the attraction between the pair balanced by the pull of the kink world lines that are attached to the vortices. Unlike the discussion in Sec. IV A 1, though, the separation of the pair is comparable to the wall thickness. Hence, it is difficult to calculate the tunneling action accurately.

If we repeat our previous analysis (even though it is not well justified here), we obtain the crude estimates

$$R \sim 4\pi\eta^2 / \sigma \sim m_a^{-1} \quad (5.4)$$

for the vortex separation, and

$$B \sim 4\pi\eta^2 \ln(1/m_a\delta_s) \sim 2\mu \quad (5.5)$$

for the bounce action.

2. $D=2,3$

In two spatial dimensions, an axion wall decays by nucleating a pair of axion vortices, and in three spatial dimensions an axion wall decays by nucleating a loop of axion string. These decay processes may be analyzed just as in Sec. III B, with μ and σ given by Eq. (5.3). However, to justify the thin-defect approximation used there, we must have

$$\ln(1/m_a\delta_s) \gg 1. \quad (5.6)$$

B. Codimension 2

Now consider the case $G_{\text{approx}} = \text{SO}(3) \rightarrow H_{\text{approx}} = \text{U}(1)$, with $G_{\text{exact}} = I$. If we ignore the intrinsic symmetry breaking, then this model contains a texture in two spatial dimensions, or a global monopole [28] in three spatial dimensions. But when the symmetry-breaking perturbation is introduced, the order parameter has a unique vacuum value. Hence, the texture collapses to a

point singularity, and the long-range field of the monopole collapses to a singular line.

If we introduce a short-distance cutoff, like a lattice spacing, then the texture wants to twist in a region with size of order the cutoff. But on that scale, there is really no notion of topology that stabilizes the texture, and there is no reason to expect a metastable defect.

To prevent the texture from shrinking indefinitely, let us introduce into the action of the model a higher-derivative ‘‘Skyrme term’’ [19]. Then there will be a classically stable defect whose decay we can analyze semiclassically.

Roughly, the energy of a texture with radius R is

$$E_{\text{texture}} \sim 4\pi \left[\frac{1}{e_{\text{Sk}}^2 R^2} + \eta^2 + \alpha^2 \eta^2 m^2 R^2 \right]; \quad (5.7)$$

here, the first term is the Skyrme term [with the coupling constant e_{Sk}^2 defined by Eq. (5.7)], the second term is the conventional gradient term, and the third term is the potential energy due to the intrinsic symmetry breaking (where m is mass of the pseudo Goldstone boson, and α^2 is a constant of order 1). By minimizing with respect to R , we find the size of the texture:

$$R_{\text{texture}}^2 \sim \frac{\alpha^{-1}}{e_{\text{Sk}} \eta m}. \quad (5.8)$$

Note that $R_{\text{texture}} \rightarrow 0$ if we turn off the Skyrme term ($e_{\text{Sk}}^2 \rightarrow \infty$), and that $R_{\text{texture}} \rightarrow \infty$ if we turn off the intrinsic breaking ($m \rightarrow 0$). The mass of the texture is

$$\mu_{\text{texture}} \sim 4\pi \eta^2 \left[1 + \frac{2\alpha m}{e_{\text{Sk}} \eta} \right]; \quad (5.9)$$

the second term can be neglected as the Skyrme term or the intrinsic symmetry breaking turns off.

In Eq. (5.7) we have made the assumption that the order parameter is close to the approximate vacuum manifold $G_{\text{approx}}/H_{\text{approx}}$. This assumption is reasonable only if the energy density inside the texture is small compared to the energy density of the ‘‘false vacuum’’ in which the G_{approx} symmetry is restored. The energy density of the false vacuum can be expressed as $\lambda\eta^4$, where λ is a scalar self-coupling; thus, Eqs. (5.8) and (5.9) hold for $\mu_{\text{texture}}/R_{\text{texture}}^2 \ll \lambda\mu^4$, or

$$\left[\frac{\lambda}{e_{\text{Sk}}^2} \right] \left[\frac{\alpha m}{e_{\text{Sk}} \eta} \right]^{-1} \left[1 + \frac{2\alpha m}{e_{\text{Sk}} \eta} \right]^{-1} \gg 1. \quad (5.10)$$

If this condition is not satisfied, there is no good reason to expect a metastable texture to exist.

If we ignore the perturbations, then the global monopole has a core size of order

$$R_{\text{core}} \sim \frac{1}{\sqrt{\lambda\eta}}, \quad (5.11)$$

where λ is a scalar self coupling; this is the linear size of the region in which the Higgs field departs significantly from its vacuum value. But the Skyrme term may distort the core significantly. If $\lambda/e_{\text{Sk}}^2 \gg 1$, then the Skyrme term dominates the gradient energy inside the core, and

we find instead

$$R_{\text{core}} \sim \left[\frac{\lambda}{e_{\text{Sk}}^2} \right]^{1/4} \frac{1}{\sqrt{\lambda\eta}}, \quad \lambda/e_{\text{Sk}}^2 \gg 1. \quad (5.12)$$

The mass of the monopole core, in order of magnitude, is

$$M_{\text{core}} \sim \begin{cases} \frac{4\pi\eta}{\sqrt{\lambda}}, & \lambda/e_{\text{Sk}}^2 \ll 1, \\ \left[\frac{\lambda}{e_{\text{Sk}}^2} \right]^{3/4} \frac{4\pi\eta}{\sqrt{\lambda}}, & \lambda/e_{\text{Sk}}^2 \gg 1. \end{cases} \quad (5.13)$$

The ratio of the texture size to the monopole core size is

$$\frac{R_{\text{texture}}^2}{R_{\text{core}}^2} \sim \begin{cases} \left[\frac{\lambda}{e_{\text{Sk}}^2} \right] \left[\frac{m}{e_{\text{Sk}} \eta} \right]^{-1}, & \lambda/e_{\text{Sk}}^2 \ll 1, \\ \left[\frac{\lambda}{e_{\text{Sk}}^2} \right]^{1/2} \left[\frac{m}{e_{\text{Sk}} \eta} \right]^{-1}, & \lambda/e_{\text{Sk}}^2 \gg 1. \end{cases} \quad (5.14)$$

Comparing with the condition Eq. (5.10), we find that $R_{\text{texture}} \gg R_{\text{core}}$. It is reasonable to expect a classically stable texture to exist, and to treat the intrinsic symmetry breaking as a small perturbation, only if the texture is large compared to the monopole core. A monopole attached to a ‘‘texture string’’ in three dimensions is illustrated in Fig. 5.

1. $D=2$

In two spatial dimensions, the texture decays by tunneling to an unwound configuration of about the same size. The bounce is a monopole-antimonopole pair in unstable equilibrium, with the attraction of the pair balanced by the pull of the strings that are attached to the monopoles. The typical separation of the pair is comparable to the size of the texture, which makes it difficult to calculate the tunneling action reliably.

Because $R_{\text{texture}} \gg R_{\text{core}}$, the action of the bounce will be dominated by the interaction between the monopoles, rather than by the core action. In order of magnitude, we expect that

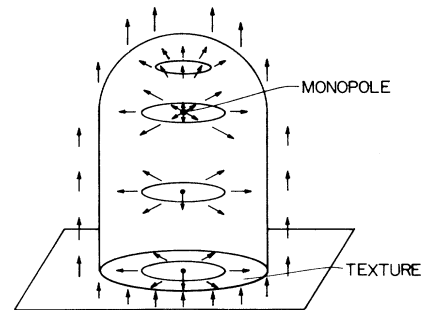

FIG. 5. Global monopole attached to a ‘‘texture string.’’ The direction of the Higgs triplet is shown by arrows. The field configuration in the asymptotic region is trivial.

$$B \sim \mu_{\text{texture}} R_{\text{texture}} \sim \frac{4\pi\eta}{e_{\text{Sk}}} \left[\frac{\alpha m}{e_{\text{Sk}}\eta} \right]^{-1/2} \left[1 + \frac{2\alpha m}{e_{\text{Sk}}\eta} \right]. \quad (5.15)$$

2. $D=3$

In three spatial dimensions, the texture becomes a string, which can decay by nucleating a monopole pair. The bounce solution is a planar string world sheet, punctured by a hole of radius R that is bounded by the world line of a monopole. However, R is comparable to the thickness of the string, so we can not justify the approximation used in Sec. III A 1, where we neglected the string thickness.

Very roughly, we can estimate the order of magnitude of the bounce action as

$$B \sim \pi \mu_{\text{string}} R_{\text{string}}^2 \sim \frac{4\pi}{e_{\text{Sk}}^2} \left[\frac{\alpha m}{e_{\text{Sk}}\eta} \right]^{-1} \left[1 + \frac{2\alpha m}{e_{\text{Sk}}\eta} \right], \quad (5.16)$$

with μ_{string} and R_{string} given by Eqs. (5.8) and (5.9).

VI. DECAY OF HEAVY DEFECTS TO LIGHT DEFECTS

We have seen that, in models with a hierarchy of symmetry breakdown, it is possible for a monopole (or string) that arises at a short distance scale to become the boundary of a string (or wall) that arises at a longer distance scale. In this section, we will comment on another logical possibility. A monopole might connect together two distinct types of string, or a string might connect together two distinct types of wall. Thus, by nucleating a monopole pair, a heavy string might decay to a light string. And by nucleating string, a heavy wall might decay to a light wall. We will illustrate these possibilities by discussing some particular examples.

A. A string bounding two walls

Consider the sequence of phase transitions

$$U(1) \times Z_2 \rightarrow Z_2' \times Z_2 \rightarrow Z_2 \rightarrow I, \quad (6.1)$$

where $U(1)$ is a gauge symmetry and Z_2 is a global symmetry. This pattern of symmetry breaking occurs in a model with three complex scalar fields ϕ , ψ , and χ , which carry $U(1)$ charges

$$Q_\phi = 2, \quad Q_\psi = 1, \quad Q_\chi = 1, \quad (6.2)$$

and transform under Z_2 as

$$Z_2: \phi \rightarrow \phi, \quad \psi \rightarrow \psi, \quad \chi \rightarrow -\chi. \quad (6.3)$$

In this model, ϕ condenses at the scale η_1 , breaking $U(1)$ to Z_2' such that

$$Z_2': \phi \rightarrow \phi, \quad \psi \rightarrow -\psi, \quad \chi \rightarrow -\chi. \quad (6.4)$$

Then ψ condenses at $\eta_2 \ll \eta_1$, breaking Z_2' . Finally χ condenses at $\eta_3 \ll \eta_2$, breaking Z_2 .

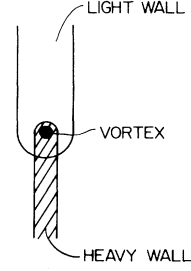

FIG. 6. Cross section of a string attached to light and heavy walls.

The symmetry breaking at scale η_1 gives rise to a string that eventually becomes the boundary of both a heavy ψ domain wall at scale η_2 , and a light χ domain wall at scale η_3 (see Fig. 6). Since the global Z_2 symmetry is spontaneously broken, there is a stable domain wall in this model, the χ wall. There is also a stable string, which carries twice the $U(1)$ flux of the minimal string that bounds two walls.

1. $D=1$

In one spatial dimension, this model contains a heavy (ψ) kink and a light (χ) kink. From the point of view of an effective field theory that describes physics well below the scale η_1 , both kinks appear to carry conserved topological charges, and so should be stable. But in the underlying theory, there is just a single topological conservation law that does not forbid the decay of a ψ kink to a χ kink. The decay of the heavy kink is mediated by the $U(1)$ vortex. As in the discussion in Sec. III B 3, the action of the bounce is

$$B \approx 2\mu, \quad (6.5)$$

where μ is the vortex action. (Integrating out the vortex generates an operator that destroys a ψ kink and creates a χ kink, with a coefficient of order $e^{-\mu}$.)

2. $D=2,3$

In two spatial dimensions, a heavy ψ wall decays to a light χ wall by nucleating a pair of vortices, and in three dimensions a ψ wall decays to a χ wall by nucleating a loop of string. These decay processes can be analyzed as in Sec. III B, except that the wall tension σ is replaced by $\sigma_\psi - \sigma_\chi$, the *difference* between the heavy and light tensions.

B. A monopole bounding two strings

Consider the sequence of phase transitions,

$$SU(3) \rightarrow U(1) \times U(1)' \rightarrow U(1) \rightarrow Z_2, \quad (6.6)$$

where $U(1) \times U(1)'$ is generated by the diagonal $SU(3)$ generators,

$$Q = \text{diag} = \left(\frac{1}{2}, -\frac{1}{2}, 0\right), \quad Q' = \text{diag} \left(\frac{1}{2}, \frac{1}{2}, -1\right), \quad (6.7)$$

and Z_2 is generated by $e^{2\pi i Q} = e^{2\pi i Q'}$. This pattern can occur in a model with an $SU(3)$ octet that condenses at scale η_1 , a triplet that condenses at $\eta_2 \ll \eta_1$, and another octet that condenses at $\eta_3 \ll \eta_2$.

When $SU(3)$ breaks to $U(1) \times U(1)'$, there are two conserved magnetic charges, and so there will be two distinct types of stable magnetic monopole. The magnetic charges of the stable monopoles are expected to be the minimal charges $(g_D/2, g_D'/2)$ and $(g_D/2, -g_D'/2)$, where g_D and g_D' are the Dirac magnetic charges associated with $U(1)$ and $U(1)'$ respectively. [These charges satisfy the Dirac quantization condition because $U(1)$ and $U(1)'$ have a nontrivial element in common.] The two monopoles need not be degenerate, unless there is a charge conjugation symmetry to enforce the degeneracy. Monopole solutions with charges $(g_D, 0)$ and $(0, g_D')$ may also exist, but they are likely to be unstable, since they can decay to minimally charged monopoles, which have lower Coulomb energy.

When the symmetry breaking proceeds further, both monopoles eventually become attached to two strings—a heavy $U(1)'$ string at scale η_2 and a light $U(1)$ string at scale η_3 . The light string is a stable Z_2 string. The model contains no stable magnetic monopole.

1. $D=2$

In two spatial dimensions, this model contains a heavy vortex that carries $U(1)'$ magnetic flux, and a light vortex that carries $U(1)$ magnetic flux. If we integrate out the monopoles, and ignore their exponentially small effects at low energy, then there are two independent conserved vortex numbers, each taking integer values.

The monopoles break these conservation laws and mediate the decay of a heavy vortex to a light vortex. The decay can be analyzed as in Sec. III B 2, and the bounce action is

$$B \approx 2m, \quad (6.8)$$

where m is the monopole action. A heavy vortex can decay to either a light vortex or a light antivortex; which decay is favored depends on which of the two monopole species is lighter.

Since the only exactly conserved vortex quantum number is a Z_2 charge, a pair of light vortices (as opposed to a vortex-antivortex pair) must be able to annihilate. The annihilation process involves monopoles of both types, and has a cross section of order $e^{-2(m_1+m_2)}$, where $m_{1,2}$ denotes the monopole action.

2. $D=3$

In three spatial dimensions, this model contains a heavy string that can decay to a light string by nucleating a monopole-antimonopole pair. The decay can be analyzed as in Sec. III B 1, but with μ replaced by $\mu_{\text{heavy}} - \mu_{\text{light}}$, the difference between the heavy and light string tensions.

VII. TEXTURE

As we noted in Sec. II D 1, global texture, even if classically stable, can always decay quantum mechanically. We discuss a few examples in this section.

A. $D=1$

To be concrete, we consider a model of a single complex scalar field φ with Lagrangian

$$L = |\partial_\mu \varphi|^2 - \lambda(|\varphi|^2 - \eta^2)^2. \quad (7.1)$$

This model has a spontaneously broken $U(1)$ global symmetry.

In one dimension, a global texture in this model wants to spread out, but we can stabilize it by imposing an infrared cutoff. Suppose we take space to be a circle with circumference L . Then a texture with topological charge n has the form

$$\varphi = e^{2\pi i n x / L}, \quad (7.2)$$

and has energy $(2\pi n)^2 / L$. We may take the limit $L \rightarrow \infty$ with the number of twists per unit length n/L held fixed. In this limit, the texture has a decay rate per unit time and length that can be computed semiclassically.

Obviously, the texture with n twists will decay to a texture with $n-1$ twists, and we can anticipate that the tunneling will take place in a region with a size of order $l \equiv L/n$, the length of a single twist. The instanton that mediates the decay is the global vortex in two Euclidean dimensions; we construct the bounce solution, and compute the tunneling action, by finding a configuration with a pair of vortices in unstable equilibrium, with boundary conditions that fix the topological charge per unit length at $\tau = \pm \infty$.

This problem is actually identical to a problem in two-dimensional electrodynamics, since the (long-range) interaction between vortices is the same as the Coulomb interaction. The boundary conditions place the vortex pair in a constant background electric field. In the unstable solution, the electric force exerted on the vortex by the antivortex is precisely canceled by the background field.

If the separation between the vortices is R , then the action is

$$B \approx 4\pi\eta^2 \ln(R/\delta_s) - 2\pi\eta^2(R/l). \quad (7.3)$$

The first term is the vortex-antivortex interaction term, and the second term is due to the interaction of the vortices with the background texture; here, $\delta_s \sim \lambda^{-1/2}\eta^{-1}$ is the size of the vortex core, and l , again, is the length of a single twist of the texture. Equation (7.3) is stationary for

$$R \approx 2l \quad (7.4)$$

and

$$B \approx 4\pi\eta^2 \ln(l/\delta_s). \quad (7.5)$$

Equation (7.5) is valid for $l \gg \delta_s$.

(Note that we can do a related calculation for the case of “gauge texture.” On a circle of finite length, the number of twists of the Higgs field is a topological invariant with a gauge-invariant meaning, and coincides with the

Chern-Simons number of the gauge field. But since these configurations are pure gauge, the states with different winding numbers are degenerate classical vacuum states, analogous to the “ n -vacua” of (3+1)-dimensional Yang-Mills theory. The gauge vortex is the two-dimensional instanton that causes these classical ground states to mix [29]. The mixing splits the degeneracy, giving rise to “ θ -vacuum” states.)

B. $D=2$

In two spatial dimensions, a global texture has an arbitrary size, and is marginally stable at the classical level. Hence, we will not discuss its semiclassical decay. The case where the texture is stabilized by suitable perturbations has already been discussed in Sec. V B.

C. $D=3$

In a model in three spatial dimensions in which a global G symmetry is broken to H , there will be global texture if $\pi_3(G/H)$ is nontrivial [2]. A global texture wants to shrink, but it can be stabilized if a higher-derivative term (“Skyrme term”) is introduced into the action of the theory [19]. As was recently pointed out by Hindmarsh [20], the Skyrme term can be generated by gauge boson exchange if an appropriate *subgroup* of G is gauged.

Crudely speaking, the energy of a texture with radius R is of order

$$E_{\text{texture}} \sim 2\pi \left[\frac{1}{e_{\text{Sk}}^2 R} + \eta^2 R \right]. \quad (7.6)$$

Here, the first term is the Skyrme term, and e_{Sk}^2 is the dimensionless Skyrme coupling constant. (In the sort of model considered by Hindmarsh [20], it is related to a gauge coupling.) The second term is the conventional (two-derivative) kinetic term, and η is the expectation value of the order parameter. Minimizing with respect to R , we find the size and mass of the texture:

$$R_{\text{texture}} \sim 1/e_{\text{Sk}} \eta, \quad M_{\text{texture}} \sim 4\pi\eta/e_{\text{Sk}}. \quad (7.7)$$

In a model that admits global texture, there is always a “global instanton” that mediates the decay of the texture. In four (or more) Euclidean dimensions, this instanton is attached to a global line defect, which we may interpret as the world line of the texture. Inside the core of the instanton, the spontaneously broken global G symmetry is “restored.”

If we suppose that the size R_{core} of the instanton core is small compared to R_{texture} , then the action contained inside a sphere of radius R_{texture} centered on the core is, in order of magnitude,

$$S_{\text{inst}} \sim 2\pi^2 \left[\frac{1}{e_{\text{Sk}}^2} \ln(R_{\text{texture}}/R_{\text{core}}) + \eta^2 (R_{\text{texture}}^2 - R_{\text{core}}^2) + \lambda \eta^4 R_{\text{core}}^4 \right]. \quad (7.8)$$

The first term is the Skyrme term, the second is the conventional kinetic term, and the third term is the potential

energy of the core; λ is a scalar self coupling that is *defined* by Eq. (7.8). Inside a larger radius $R \gg R_{\text{texture}}$, the action is dominated by the linear defect, so we have $S_{\text{inst}} \sim M_{\text{texture}} R$.

Assuming that $\lambda/e_{\text{Sk}}^2 \gg 1$, we find that S_{inst} is minimized for

$$R_{\text{core}}^4 \sim \frac{e_{\text{Sk}}^2}{\lambda} R_{\text{texture}}^4, \quad (7.9)$$

so that the assumption $R_{\text{core}} \ll R_{\text{texture}}$ is justified, and the instanton action (cut off at $R \sim R_{\text{texture}}$) is

$$S_{\text{inst}} \sim \frac{\pi^2}{2e_{\text{Sk}}^2} \ln(\lambda/e_{\text{Sk}}^2). \quad (7.10)$$

When it decays, the texture tunnels to an “unwound” configuration with core size of order R_{texture} , which is then free to dissipate. The bounce solution that describes this decay is a pair of global instantons in unstable equilibrium, with the pull of the texture balanced by the instanton–anti-instanton attraction. The separation between the instantons in equilibrium is of order R_{texture} , and, for $\lambda/e_{\text{Sk}}^2 \gg 1$, the action of the bounce is

$$B \approx 2S_{\text{inst}} \sim \frac{\pi^2}{e_{\text{Sk}}^2} \ln(\lambda/e_{\text{Sk}}^2). \quad (7.11)$$

The decay is strongly suppressed in the limit $e_{\text{Sk}}^2 \rightarrow 0$, where the texture becomes large. It is also suppressed, much more weakly, as the “barrier height” $\lambda\eta^4$ gets large.

VIII. SEMILOCAL AND ELECTROWEAK STRINGS

Like the strings that we discussed in Secs. III and IV, semilocal and electroweak strings can end on magnetic monopoles, not because of a symmetry-breaking hierarchy, but for other reasons. Here we will estimate the tunneling action for the decay of semilocal and electroweak vortices, in two dimensions, and for the breaking of semilocal and electroweak strings, in three dimensions. The analysis is similar in spirit to that described in Secs. III and IV, but differs in detail. Actually, our estimates will be very crude; to do a better job, one would need to study the interactions of the monopoles in more detail.

A. Semilocal defects

Recall from the discussion in Sec. II D 2 that a semilocal model has a “topologically conserved” magnetic flux (in two dimensions), yet there are configurations of finite energy in which the flux is spread out over an arbitrarily large area. In these configurations, the Higgs field takes values in the vacuum manifold everywhere, and there is no Higgs-field potential energy. If the size R of the configuration is very large, the Coulomb energy of the magnetic flux can also be neglected; then the only contribution to the energy is due to Higgs-field gradients. In two dimensions, gradient energy is scale invariant, and so remains finite and nonzero as $R \rightarrow \infty$. In the sector with a single quantum of magnetic flux, let us denote the minimum energy in the limit $R \rightarrow \infty$ by

$$E_\infty = \alpha_\infty \eta^2, \tag{8.1}$$

where η is the magnitude of the Higgs-field expectation value. Here α_∞ is a numerical factor of order 1; it depends on the geometry of the vacuum manifold, but not on any coupling constants or parameters of the theory.

There are also “vortex” configurations, in which the magnetic flux is confined to a core of finite size. The characteristic feature of the vortex is that the stability group of the Higgs field is different at its center than in the vacuum; thus, the vortex carries Higgs field potential energy. Let us suppose that there is a vortex solution to the classical field equations with energy

$$E_s = \alpha_s \eta^2. \tag{8.2}$$

The structure of the core depends on the detailed dynamics of the theory, so α_s has a nontrivial dependence on coupling constants.

Now, if $\alpha_s > \alpha_\infty$, then the vortex is not stable. But it may or may not be metastable. In fact, in the one model that has been studied in detail (the minimal electroweak model in the limit $\sin^2\theta_W = 1$), it turns out that the vortex is either absolutely stable or classically unstable [22,30]. Nevertheless, we will ask what would happen if there is a classically stable vortex with $\alpha_s > \alpha_\infty$.

To understand the decay of the semilocal strings and vortices, it is important to recognize that a semilocal string can end on a (global) monopole [22,14]. In the notation of Sec. II D 2, the defining property of a semilocal model is that a closed path that is noncontractible in the gauge orbit G_1/H_1 can be contracted in the full vacuum manifold $[G_1 \times G_2]/H$. On a large sphere that surrounds the monopole, a quantum of G_1/H_1 magnetic flux enters through the core of a vortex at, say, the south pole. The Higgs field configuration on the sphere excluding the south pole is just a deformation of the nontrivial loop in G_1/H_1 to a point; on each line of constant latitude, the Higgs field executes a closed path in the vacuum manifold, which becomes a trivial path at the north pole. Thus, a quantum of confined magnetic flux is converted in the core of the monopole to unconfined flux that spreads and returns to spatial infinity. The energy of the monopole is infrared divergent, for the Higgs-field gradient energy inside a sphere of radius R is of order $\alpha_\infty \eta^2 R$ (excluding the energy of the vortex).

To be concrete, let us suppose that the gauge group is $G_1 = U(1)$, and is completely broken. We denote the gauge coupling by g' , in deference to the analogy with the hypercharge coupling in the standard model.

1. $D=2$

A metastable semilocal vortex will tunnel to a configuration with the same energy that does not have significant Higgs-field potential energy stored in its core. If this configuration has radius R , we can estimate its energy as $\alpha_\infty \eta^2 + 4\pi/g'^2 R^2$, where the first term is due to Higgs-field gradients and the second is due to the magnetic flux. Equating with the vortex mass $\alpha_s \eta^2$, we find $R \sim \sqrt{4\pi(\alpha_s - \alpha_\infty)^{-1/2} (g'\eta)^{-1}}$.

To compute the tunneling action, we construct the bounce. It consists of a monopole-antimonopole pair in

unstable equilibrium in three-dimensional Euclidean space (see Fig. 7). If we assume that $\alpha_s - \alpha_\infty \ll 1$, then the pair will be widely separated, and the interaction “energy” can be well approximated by a linear plus Coulomb potential. Thus, if R is the separation, the action is

$$B \approx 2m_{\text{core}} - \alpha_s \eta^2 R + \alpha_\infty \eta^2 R - 4\pi/g'^2 R; \tag{8.3}$$

the first term is the core action of the monopoles, the second is the action of the missing string, the third is the linear interaction of the monopoles, and the fourth is the Coulomb term. (We have normalized the gauge coupling so that $4\pi/g'$ is the magnetic flux quantum.) This expression is stationary for

$$R^2 \approx \frac{4\pi}{(\alpha_s - \alpha_\infty) g'^2 \eta^2}, \tag{8.4}$$

as we anticipated. For $\alpha_s - \alpha_\infty$ small, the bounce action is dominated by the core action of the monopoles:

$$B \approx 2m_{\text{core}}. \tag{8.5}$$

We expect $m_{\text{core}} \sim 4\pi\eta/g'$, for this is the magnetic self-energy of a monopole with core size of order the vortex width $\delta_s \sim (g'\eta)^{-1}$.

2. $D=3$

A metastable semilocal string will decay by nucleating a monopole-antimonopole pair. If $\alpha_s - \alpha_\infty$ is small, then the pair will be sufficiently distantly separated right after the tunneling that the Coulomb interaction between the monopoles can be neglected. If the pair nucleates with separation L , then the energy $\alpha_s \eta^2 L$ saved by removing the string must balance the energy $2m_{\text{core}} + \alpha_\infty \eta^2 L$ of the pair (where m_{core} is the mass of the monopole core). We conclude that $L \approx 2m_{\text{core}}/(\alpha_s - \alpha_\infty)\eta^2$.

As in our previous calculations of string decay due to monopole pair nucleation, the bounce solution is a planar string world sheet with a circular hole of radius R , the hole bounded by the world line of the monopole. If the Coulomb interaction is neglected, we can calculate R and the tunneling action using a minor modification of the

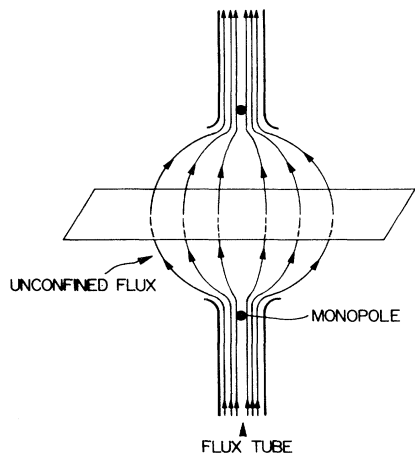

FIG. 7. Instanton for semilocal vortex decay. The magnetic field pattern in a plane containing the monopoles is shown.

method in Sec. II A 1. The modification is that the string tension μ is replaced by $(\alpha_s - \alpha_\infty)\eta^2$, the difference between the string tension and the coefficient in the monopole linear potential, and m is replaced by the core mass m_{core} . Then, from Eq. (3.5) and (3.6), we find

$$R \approx \frac{m_{\text{core}}}{(\alpha_s - \alpha_\infty)\eta^2} \quad (8.6)$$

and

$$B \approx \frac{\pi m_{\text{core}}^2}{(\alpha_s - \alpha_\infty)\eta^2}. \quad (8.7)$$

B. Electroweak defects

Now consider the case of a semilocal model with $\alpha_s < \alpha_\infty$, so that a vortex is *stable*. Let us ask what would happen if we were to gauge the global G_2 symmetry. To be concrete, consider an interesting example—the standard electroweak model with gauge group $SU(2)_L \times U(1)_Y$ and a Higgs doublet. If we turn off the $SU(2)_L$ gauge coupling g , this becomes a semilocal model; the gauge group $U(1)_Y$ is broken, but a noncontractible loop in the gauge orbit is contractible in the full vacuum manifold. The vortex turns out to be stable, in this limit, if the Higgs-boson mass is less than the Z^0 mass [22,30].

For $g \neq 0$, there is no longer a topological conservation law, and the vortex is no longer absolutely stable. Only a finite energy barrier separates a vortex with heavy Z^0 magnetic flux from a configuration with massless A magnetic flux that is free to spread out. Correspondingly (as Nambu [31] observed long ago), a Z^0 string can end on an *electromagnetic* monopole (see Fig. 8). The quantity of Z^0 flux trapped in the string is [31,14]

$$\Phi_Z = 4\pi \sin\theta / g', \quad (8.8)$$

and the quantity of A flux emanating from the monopole is

$$\Phi_A = 4\pi \sin\theta / g \quad (8.9)$$

(where $\tan\theta \equiv g'/g$).

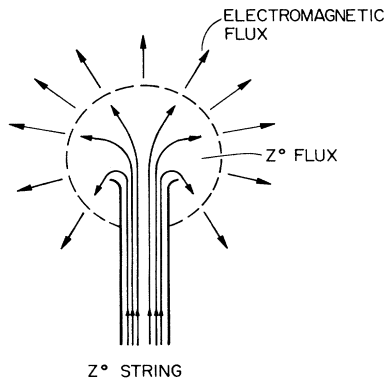

FIG. 8. Electroweak string terminating on an electroweak monopole. The magnetic field pattern on a slice through the string and monopole is shown. The monopole converts the (confined) Z^0 flux to (unconfined) electromagnetic flux.

In the limit $g \ll g'$ (or $\sin\theta \approx 1$), the monopole has a core size that is large compared to thickness of the string $\delta_s \sim m_Z^{-1}$ (where m_Z is the Z^0 mass). Deep inside the core, it resembles the semilocal monopole, with spreading Z^0 flux. At a radius R_{core} , the Z^0 flux is converted to A flux. The core radius is determined by the competition between the linearly divergent energy of the “global” monopole and the magnetic self-energy. Roughly, the core energy is

$$E_{\text{core}} \sim \alpha_\infty \eta^2 R_{\text{core}} + \frac{2\pi \sin^2\theta}{g'^2} (m_Z - R_{\text{core}}^{-1}) + \frac{2\pi \sin^2\theta}{g^2} R_{\text{core}}^{-1}, \quad (8.10)$$

where the second term is due to the Z^0 flux and the third term is due to the A flux. By minimizing with respect to R_{core} , we find

$$R_{\text{core}}^2 \approx \frac{-2\pi \cos 2\theta}{\alpha_\infty g^2 \eta^2} \approx \frac{2\pi}{\alpha_\infty g^2 \eta^2} \quad (8.11)$$

(the second equality following from our assumption $g \ll g'$), and

$$E_{\text{core}} \approx \sqrt{4\pi\alpha_\infty} \frac{\eta}{g}. \quad (8.12)$$

1. $D=2$

In two dimensions, an electroweak vortex decays by tunneling to a configuration in which its Z^0 flux has been converted to A flux. In the limit $g \ll g'$ the flux Φ_A given by Eq. (8.9) is much larger than Φ_Z . Therefore, A flux is energetically very costly; to be degenerate with the vortex, the configuration after tunneling must be very large.

The bounce solution is a monopole-antimonopole pair in unstable equilibrium in three Euclidean dimensions, with the Coulomb attraction of the pair compensated by the tension in the electroweak strings. For typical values of the parameters, the separation R of the pair will be comparable to the size R_{core} of the monopole, which makes it difficult to estimate the tunneling action reliably. But if we assume that $R \gg R_{\text{core}}$, then the action of the configuration is

$$B \approx 2E_{\text{core}} - \alpha_s \eta^2 R - \frac{4\pi \sin^2\theta}{g^2 R}, \quad (8.13)$$

which is stationary for

$$R^2 \approx \frac{4\pi \sin^2\theta}{\alpha_s g^2 \eta^2} \approx \frac{4\pi}{\alpha_s g^2 \eta^2} \quad (8.14)$$

(assuming $\sin^2\theta \approx 1$). Thus, our assumption $R \gg R_{\text{core}}$ is justified under the (not very physical) condition

$$\alpha_s / \alpha_\infty \ll 1. \quad (8.15)$$

The tunneling action is

$$B \approx 2E_{\text{core}} - \sqrt{4\pi\alpha_s} \sin\theta \frac{\eta}{g} \approx 2E_{\text{core}}; \quad (8.16)$$

it is dominated by the core action for $\alpha_s \ll \alpha_\infty$.

2. $D=3$

An electroweak string decays by nucleating a monopole-antimonopole pair. Typically, the string will tunnel to a configuration in which the separation of the pair is comparable to the monopole core size, but if we assume that $\alpha_s \ll \alpha_\infty$, then the core is sufficiently small that the analysis of Sec. III A 1 applies, with $m = E_{\text{core}}$ and $\mu = \alpha_s \eta^2$. Thus, the monopole world line has radius

$$R \approx E_{\text{core}} / \alpha_s \eta^2 \approx \frac{\sqrt{4\pi\alpha_\infty}}{\alpha_s g \eta} \quad (8.17)$$

(for $\sin^2\theta \sim 1$), and the bounce action is

$$B \approx \pi E_{\text{core}}^2 / \alpha_s \eta^2 \approx \frac{4\pi^2}{g^2} \frac{\alpha_\infty}{\alpha_s}. \quad (8.18)$$

So, of course, the decay is heavily suppressed as $g^2 \rightarrow 0$.

IX. CONCLUDING REMARKS

A. Summary

In this paper, we have studied the decay of metastable defects arising from symmetry breaking in relativistic field theories. The decay occurs through quantum tunneling; for example, strings decay by nucleation of monopole-antimonopole pairs, and domain walls decay by nucleation of circular holes bounded by strings. We also studied the decay of defects in one and two-dimensional systems and the decay of nontopological defects, such as global texture and semilocal and electroweak strings.

The decay probability is determined by an instanton which can be found by solving Euclidean field equations with appropriate boundary conditions. The problem is greatly simplified when the dimensions of the instanton are much greater than the size of the defect core, so that the thin defect approximation can be used. We assumed the validity of this approximation in most of our calculations.

We have estimated the instanton action for the decay of various defects in $D=1, 2$, or 3 spatial dimensions. We found that the decay rate of defects arising from a global symmetry breaking is strongly suppressed compared to the decay rate in the corresponding gauge theory. In particular, the instanton action for the decay of a global string is exponentially large [see Eq. (4.26)]. But even in gauge theories, the tunneling action is large and the decay rate is correspondingly small in the case where two different symmetry-breaking scales are widely separated.

In conclusion, we would like to comment on some possible applications and extensions of our results.

B. Thin-defect approximation

The thin-defect approximation is similar to the thin-wall approximation in the vacuum decay problem [24]. This latter approximation is in bad repute, since it is

known to apply only to a very limited class of potentials [32]. On the other hand, the thin-defect approximation applies if the symmetry-breaking scales for the two types of defects involved in the decay are substantially different. This is a typical situation in elementary particle theories, and thus we expect our results to have a reasonably wide range of validity.

C. “Embedded” defects

Let us briefly consider the behavior of the decay rate when the two symmetry-breaking scales are close together. Though the thin-defect approximation does not apply in this case, we can roughly estimate the tunneling action by using our thin-defect formulas. For example, consider the breaking of a string due to monopole nucleation. The monopole mass can be crudely estimated as

$$m \sim 4\pi\eta_1/e, \quad (9.1)$$

where η_1 is the higher symmetry-breaking scale and e is the gauge coupling, and the string tension is roughly

$$\mu \sim 2\pi\eta_2^2, \quad (9.2)$$

where η_2 is the lower symmetry-breaking scale. Then the tunneling action Eq. (3.6) becomes

$$B \approx \pi m^2 / \mu \sim \frac{8\pi^2}{e^2} \left(\frac{\eta_1}{\eta_2} \right)^2. \quad (9.3)$$

Naturally, the behavior of this expression as η_1 approaches η_2 (aside from the numerical factor $8\pi^2$, which should not be taken too seriously anyway), could be determined by dimensional analysis, as e^{-2} has the dimensions of \hbar .

There is no guarantee that a *classically stable* string solution will continue to exist as the two symmetry-breaking scales approach each other. However, if the Higgs potential obeys suitable conditions, one can argue that there is a static solution for $\eta_1 = \eta_2$, although it may be unstable. This is a special case of the “embedded” string recently described by Vachaspati and Barriola [33]. Equation (9.3) suggests that, if an embedded string is classically stable, its quantum-mechanical decay rate is likely to be small, in a weakly coupled theory. Of course, it is a fact of life that our semiclassical (small \hbar) approximation is reliable, then the tunneling action is large and the decay rate is small.

We can do a similar estimate of the rate for the decay of a domain wall due to nucleation of a string loop. Taking the string tension to be

$$\mu \sim 2\pi\eta_1^2 \quad (9.4)$$

and the wall tension to be

$$\sigma \sim 2\sqrt{\lambda}\eta_2^2, \quad (9.5)$$

where λ is a scalar self-coupling, Eq. (3.13) becomes

$$B \approx \frac{16\pi\mu^3}{3\sigma^2} \sim \frac{32\pi^4}{3\lambda} \left(\frac{\eta_1}{\eta_2} \right)^6. \quad (9.6)$$

If there is a classically stable “embedded” domain wall for $\eta_1 = \eta_2$, it will be long lived at weak coupling.

D. Cosmological applications

The very small decay rates for metastable defects do not necessarily mean that such decay processes are observationally irrelevant. Consider for example metastable strings formed in the sequence of cosmological phase transitions (1.3). The first phase transition gives rise to monopoles and the second to strings which connect monopole-antimonopole pairs. Even if we disregard the breaking of the string due to the quantum-mechanical decay process, such hybrid defects typically disappear long before the present epoch [7]. The string energy is dissipated by friction and by radiation of gauge quanta and of gravitational waves. As the strings get shorter, the monopoles are pulled close together; they eventually capture one another into Coulombic bound states and annihilate. In this scenario, the demise of the monopole-string system is so rapid that the slow monopole nucleation process has very little effect.

But the evolution can be quite different if there is a period of inflation between the two phase transitions in (1.3). In this case the monopoles can be diluted beyond the present horizon, and the evolution of strings will initially be similar to that of topologically stable strings. However, at some point the string decay by monopole pair nucleation will become important. To estimate the time t_* when this happens, we write the nucleation probability per unit string length per unit time as

$$P = A\mu \exp(-\pi m^2/\mu), \quad (9.7)$$

where A is a dimensionless coefficient and we have used (3.6) for the tunneling action. The strings stretching across the horizon at cosmic time t have length of order t ; so the condition for approximately one pair per horizon volume to nucleate on a given string by cosmic time t_* is $Pt_*^2 \sim 1$, or

$$t_* \sim (A\mu)^{-1/2} \exp(\pi m^2/2\mu). \quad (9.8)$$

With a grand-unification symmetry-breaking scale for strings, $\mu^{1/2} \sim 10^{16}$ GeV, and assuming that A is not very different from 1, this time is smaller than the present age of the Universe if $m^2/\mu \leq 85$.

At $t \sim t_*$ the strings are cut into pieces of length $\sim t_*$ with monopoles at the ends. For large values of t_* it may take a long time to dissipate the string energy, and oscillating string pieces may still be flying somewhere in the Universe. As they are pulled by the strings, the monopoles are accelerated to energies comparable to the ener-

gy of the string, $E \sim \mu t_*$. If t_* is close to the present time, then, for grand-unification strings this energy corresponds to a mass of order 10^{17} solar masses. A monopole will move ultrarelativistically, with its gravitational field concentrated in the transverse plane and the gravitational force decreasing as r^{-1} with the distance from the monopole. Gravitational effects of such supermassive relativistic objects can be quite significant.

E. Nonzero temperatures

Our results can be easily extended to the case of defect decay at a nonzero temperature T . The Euclidean path integral in this case is taken over field configurations periodic in imaginary time τ with a period $\Delta\tau = T^{-1}$, and the instanton solutions should have the same periodicity. At sufficiently low temperatures, the finite- T instanton is simply the zero- T instanton periodically repeated along the τ axis [34,35]. The effects of periodicity become important when T becomes comparable to the inverse size of the instanton, R^{-1} . At still higher temperatures, the decay of the defect tends to be dominated by thermal fluctuations rather than quantum fluctuations. The interesting and somewhat unexpected behavior of instantons at higher temperatures will be discussed in a separate paper [36].

F. Condensed matter applications

Condensed matter systems exhibit a fascinating variety of defects, many of which are metastable, at least in principle. For example, superfluid $^3\text{He-B}$ contains domain walls that can terminate on strings [37], and both nematic liquid crystals [38] and $^3\text{He-A}$ [39] contain strings that can terminate on monopoles. In suitable materials, the decay of walls due to string nucleation and of strings due to monopole nucleation may occur at observable rates. Also, liquid crystals and ^3He can contain textures that may decay either quantum mechanically or due to thermal fluctuations.

In these cases, the simplifying assumptions of Lorentz invariance and the thin-defect approximation may not apply. But the instantons corresponding to the decay processes have the same general structure as the instantons that we have constructed, and the decay rates can be estimated using the methods described here.

ACKNOWLEDGMENTS

This work was supported in part by DOE Contract No. DE-AC03-81-ER40050 and by NSF Contract No. 8605578. A. V. gratefully acknowledges the hospitality of Caltech, and thanks the Sherman Fairchild Distinguished Scholars program for financial support.

-
- [1] S. Coleman, in *New Phenomena in Subnuclear Physics*, edited by A. Zichichi (Plenum, London, 1977).
 [2] T. W. B. Kibble, *J. Phys. A* **9**, 1387 (1976).
 [3] A. Vilenkin, *Phys. Rep.* **121**, 263 (1985).
 [4] J. Preskill, in *Architecture of the Fundamental Interactions at Short Distances*, Proceedings of the Les Houches Summer School, Les Houches, France, 1985, edited by P. Ra-

- mond and R. Stora, Les Houches Summer School Proceedings Vol. 44 (North-Holland, Amsterdam, 1987).
 [5] T. W. B. Kibble, G. Lazarides, and Q. Shafi, *Phys. Rev. D* **26**, 435 (1982).
 [6] A. E. Everett and A. Vilenkin, *Nucl. Phys.* **B207**, 43 (1982).
 [7] A. Vilenkin, *Nucl. Phys.* **B196**, 240 (1982).
 [8] T. Vachaspati, “Electroweak Strings,” Tufts Report No.

- TUTP-92-3, 1992 (unpublished); Phys. Rev. Lett. **68**, 1977 (1992).
- [8a] F. A. Bais, Phys. Lett. **98B**, 437 (1981).
- [9] S. Coleman, in *The Unity of Fundamental Interactions*, edited by A. Zichichi (Plenum, New York, 1983).
- [10] M. Srednicki and L. Susskind, Nucl. Phys. **B179**, 239 (1981).
- [11] L. M. Krauss and F. Wilczek, Phys. Rev. Lett. **62**, 1221 (1989).
- [12] A. K. Gupta, J. Hughes, J. Preskill, and M. B. Wise, Nucl. Phys. **B333**, 195 (1990).
- [13] J. Preskill and L. M. Krauss, Nucl. Phys. **B341**, 50 (1990).
- [14] J. Preskill, Phys. Rev. D **46**, 4218 (1992).
- [15] M. Hindmarsh and T. W. B. Kibble, Phys. Rev. Lett. **55**, 2398 (1985).
- [16] P. Sikivie, Phys. Rev. Lett. **48**, 1156 (1982).
- [17] G. Lazarides and Q. Shafi, Phys. Lett. **115B**, 21 (1982).
- [18] A. Vilenkin and A. E. Everett, Phys. Rev. Lett. **48**, 1867 (1982).
- [19] T. H. R. Skyrme, Proc. R. Soc. London **A260**, 127 (1961); E. Witten, Nucl. Phys. **B223**, 433 (1983).
- [20] M. Hindmarsh, "Semilocal Topological Defects," DAMTP Report No. DAMTP-HEP-92-24, 1992 (unpublished).
- [21] T. Vachaspati and A. Achúcarro, Phys. Rev. D **44**, 3067 (1991).
- [22] M. Hindmarsh, Phys. Rev. Lett. **68**, 1263 (1991).
- [23] M. James, L. Perivolaropoulos, and T. Vachaspati, Phys. Rev. D **46**, R5232 (1992).
- [24] S. Coleman, Phys. Rev. D **15**, 2929 (1977).
- [25] S. Coleman, Nucl. Phys. **B298**, 178 (1988).
- [26] R. Peccei and H. Quinn, Phys. Rev. Lett. **38**, 1440 (1977).
- [27] S. Weinberg, Phys. Rev. Lett. **40**, 223 (1978); F. Wilczek, Phys. Rev. Lett. **40**, 279 (1982).
- [28] M. Barriola and A. Vilenkin, Phys. Rev. Lett. **63**, 341 (1989).
- [29] C. Callan, R. Dashen, and D. Gross, Phys. Lett. **66B**, 375 (1977).
- [30] A. Achúcarro, K. Kuijen, L. Perivolaropoulos, and T. Vachaspati, "Dynamical Simulations of Semilocal Strings," CFA Report No. 3384, 1992 (unpublished).
- [31] Y. Nambu, Nucl. Phys. **B130**, 505 (1977).
- [32] D. A. Samuel and W. A. Hiscock, Phys. Lett. B **261**, 251 (1991).
- [33] T. Vachaspati and M. Barriola, Phys. Rev. Lett. **69**, 1867 (1992).
- [34] I. Affleck, Phys. Rev. Lett. **46**, 388 (1981).
- [35] A. D. Linde, Nucl. Phys. **B216**, 421 (1983).
- [36] J. Garriga and A. Vilenkin (unpublished).
- [37] M. M. Salomaa and G. E. Volovik, Phys. Rev. B **37**, 9298 (1988).
- [38] C. Williams, P. Pieranski, and P. E. Cladis, Phys. Rev. Lett. **29**, 90 (1972).
- [39] P. W. Anderson and G. Toulouse, Phys. Rev. Lett. **38**, 403 (1977).